

MENTO

Your link to improved performance

Pressure Safety Products



PRODUCT SELECTION GUIDE



PERFORMANCE UNDER PRESSURE



Continental Disc Corporation manufactures rupture discs to our customers' specifications which protect vessels, equipment and systems against damaging overpressure conditions.

QUALITY

Quality begins during our first contact with you. That quality is an integral part of every step we take to provide you with what you expect to receive. All manufacturing is performed under an approved ISO 9001 Quality Assurance System. Continental Disc Corporation can supply rupture discs certified to the standards of ASME, the European Pressure Equipment Directive, 3A Sanitary Standards Council and many others.

SERVICE

A commitment to supply the services you expect:

- Technical assistance, training and support
- Fast, technical, easily understood quotations
- Providing product to your specifications
- Shipping schedules that are unmatched in the industry

Continental Disc Corporation offers an emergency service program to meet your needs. Shipping schedules are adjusted daily to meet your emergency requirements.

WHAT'S INSIDE...

TABLE OF CONTENTS

RUPTURE DISCS

REVERSE ACTING

HPX®.....	8
HPX-Ta™.....	8
LOTRX®.....	9
RCS.....	9
SANITRX HPX®.....	10
SANITRX HPX® II.....	10
SANITRX® LPX.....	11



TENSION/FORWARD ACTING

MICRO X®.....	12
Composite Flat Seat.....	12
Standard 30° Seat.....	13
Composite 30° Seat.....	13
ENVIRO-SEAL.....	15
GRAFSERT®.....	15
Tite-Seal Assembly.....	16
WMP-Welded Muffled Plug... 16	
ICON.....	17
PC-SERT.....	17
Tanksert.....	17

ULTRA-LOW PRESSURE

CAL-VAC®.....	14
POS-A-SET®.....	14

RUPTURE DISC HOLDERS

Insert Type.....	21
HPX-PT Pre-Torqued.....	21
Double Disc.....	22
Union Type.....	22
Full-Bolted.....	22
Screw Type.....	22
CLEAN-SWEEP®.....	22
CAL-VAC®/POS-A-SET®.....	22



MISCELLANEOUS

Vent Panels.....	18
Burst Disc Indicator Systems....	19
Special Assemblies.....	20
Industries Served.....	23

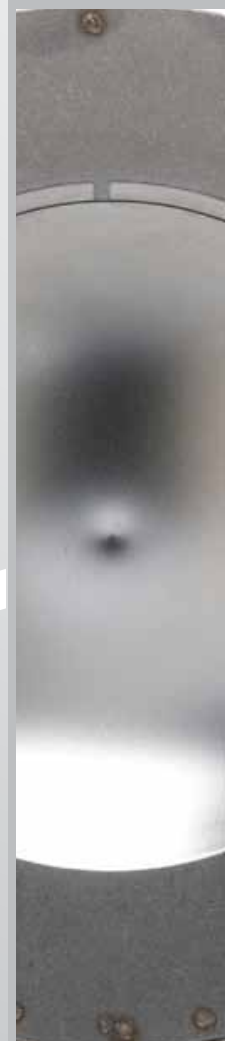

RUPTURE DISC SELECTION TREE

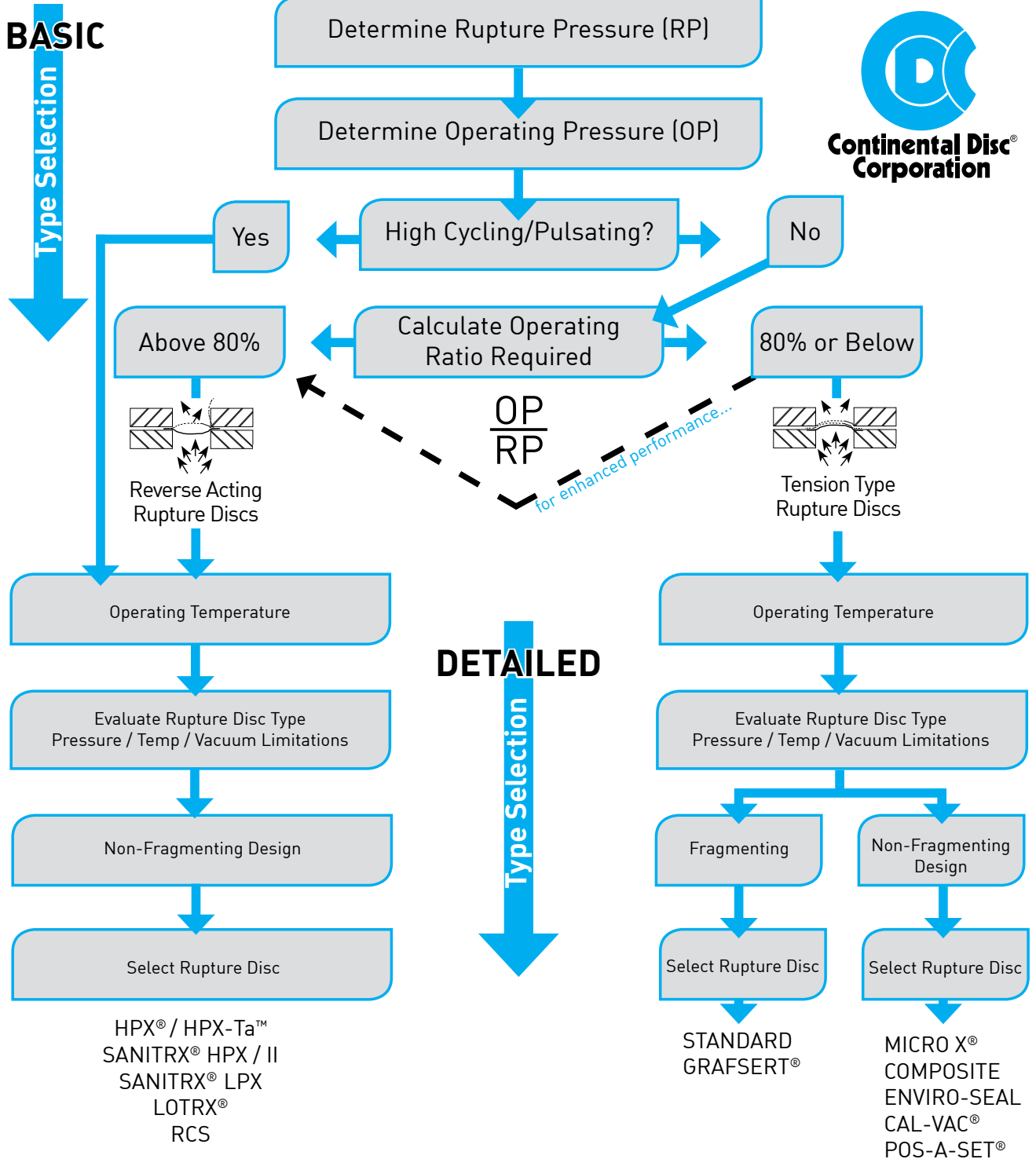

Don't Forget to Consider:

- > Gas or Liquid Service
- > Primary/Secondary/Relief Valve
- > Material Requirements (Corrosion & Temperature)
- > Other factors may apply when choosing a rupture disc

TENSION TYPE RUPTURE DISCS

Fig. A

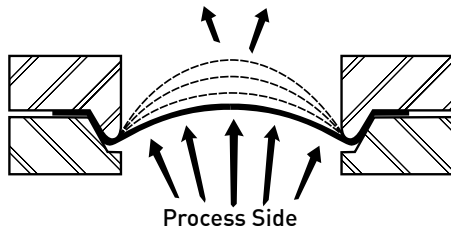
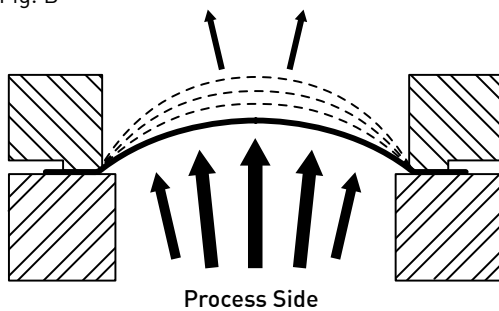

Fig. B



Tension Type Rupture Discs are oriented in a system with the process media pressure against the concave side of the rupture disc (Figure A, 30° Seat; Figure B, Flat Seat). As the process pressure increases beyond the allowable operating pressure, the rupture disc starts to grow. This growth will continue as the pressure increases, until the tensile strength of the material is reached and rupture occurs.

No single type of rupture disc will meet all the numerous applications of an industry.

Each type of rupture disc, tension or reverse acting, has its own characteristics and capabilities.

REVERSE ACTING RUPTURE DISCS

Fig. C

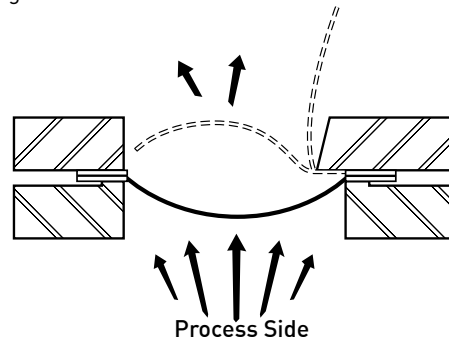

Reverse Acting Rupture Discs are oriented in a system with the process media pressure against the convex side of the disc (Figure C), placing the rupture disc in compression. As the burst pressure rating of the disc is reached, the compression loading on the rupture disc causes it to reverse, snapping through the neutral position and causing it to open by a predetermined scoring pattern.

A reverse acting rupture disc provides some advantages, as compared to tension type rupture discs, which may warrant consideration when selecting a rupture disc.

These advantages include:















- Available with maximum recommended operating pressure ratios up to 95% of the stamped burst pressure
- Up to full vacuum capabilities without the need of an additional support member
- Longer service life under cyclic or pulsating conditions
- Constructed using thicker materials providing greater resistance to corrosion

This guide provides a brief overview of the various tension and reverse acting design rupture discs, holders, accessories and options offered by Continental Disc Corporation. For detailed information regarding a specific design, refer to specific product literature, speak with your local representative or contact the factory directly.

TYPE OF DISC

































RUPTURE DISC SELECTION TABLE

CONTINENTAL DISC CORPORATION RUPTURE DISC TYPE	PROCESS ENVIRONMENT	SIZE	BURST PRESSURE RANGE	RECOMMENDED MAX. OPERATING TO BURST PRESSURE RATIO	MANUFACTURING RANGE	VACUUM SUPPORT REQUIRED TO WITHSTAND FULL VACUUM	STANDARD MATERIALS**							
							ALUMINUM	MONEL	INCONEL	NICKEL	316 SS or 316L SS	HASTELLOY® C	TANTALUM	GRAPHITE
HPX® 	Gas or Liquid (static, cyclic or pulsating)	1" - 12" 25 - 300 mm	10 - 2000 psig 0,689 - 13,8 barg	90% or 95%	ZERO -5% -10%	NO		+	+	+	+	+		
HPX-Ta™ 	Gas or Vapor (static, cyclic or pulsating)	1" - 12" 25 - 300 mm	10 - 800 psig 0,689 - 55,2 barg	90%	ZERO -5% -10%	NO								+
LOTRX® 	Gas or Liquid (static, cyclic or pulsating)	1" - 8" 25 - 200 mm	1,5 - 30 psig 0,103 - 2,07 barg	90%	ZERO -5% -10%	NO*		+	+	+	+	+	+	
RCS 	Gas (static, cyclic or pulsating)	14" - 32" 350 - 800 mm	20 - 180 psig 1,38 - 12,4 barg	90%	ZERO -5% -10%	NO		+	+	+	+	+		
SANITRX HPX® 	Gas or Liquid (static, cyclic or pulsating)	1" - 3" 25 - 80 mm	10 - 250 psig 0,689 - 17,2 barg	90% or 95%	ZERO -5% -10%	NO		+	+	+	+	+		
SANITRX HPX® II 	Gas or Liquid (static, cyclic or pulsating)	1½" - 4" 40 - 100 mm	10 - 500 psig 0,689 - 34,5 barg	90% or 95%	ZERO -5% -10%	NO		+	+	+	+	+		
SANITRX® LPX 	Gas (static, cyclic or pulsating)	1½" - 3" 40 - 80 mm	5,8 - 10 psig 0,40 - 0,689 barg	90%	ZERO	NO					+			
MICRO X® 	Gas or Liquid (static)	1" - 36" 25 - 900 mm	15 - 3600 psig 1,03 - 248 barg	80%	ZERO -5% -10%	NO*		+	+	+	+	+	+	
COMPOSITE FS 	Gas or Liquid (static, cyclic or pulsating)	11/16" - 36" 17,5 - 900 mm	2 - 1440 psig 0,138 - 99,3 barg	80%	Standard, ¾, ½, ¼, ZERO	YES	+	+	+	+	+	+	+	
STANDARD 30° SEAT 	Gas or Liquid (static, cyclic or pulsating)	¼" - 30" 6 - 750 mm	3 - 75,000 psig 0,207 - 5171 barg	70%	Standard ¾, ½	YES	+	+	+	+	+	+	+	
COMPOSITE 30° SEAT 	Gas or Liquid (static, cyclic or pulsating)	1" - 30" 25 - 750 mm	2 - 1440 psig 0,138 - 99,3 barg	80%	Standard, ¾, ½, ¼, ZERO	YES	+	+	+	+	+	+	+	
CAL-VAC® 	Gas or Liquid (static, cyclic or pulsating)	3" - 12" 80 - 300 mm	1 - 115 INWC	Within 1 INWC of min setting	6 INWC min/ max	NOT Applicable		+	+	+	+	+	+	
POS-A-SET® 	Gas or Liquid (static, cyclic or pulsating)	3" - 12" 80 - 300 mm	1 - 115 INWC	Within 1 INWC of min setting	6 INWC min/ max	NOT Applicable		+	+	+	+	+	+	
ENVIRO-SEAL 	Gas or Liquid (static, cyclic or pulsating)	1" - 36" 25 - 900 mm	1 - 59 psig 0,069 - 4,07 barg	50%	Min./ Max	NO*		+	+	+	+	+	+	
GRAFSERT® 	Gas or Liquid (static, cyclic or pulsating)	½" - 24" 13 - 600 mm	0,25 - 720 psig 0,017 - 49,6 barg	80%	ZERO	NO*								+

*Dependent upon burst pressure.

**Materials not indicated or shown may be available by special design. Contact the factory.

RUPTURE DISC SELECTION TABLE

CONTINENTAL DISC CORPORATION RUPTURE DISC TYPE	FLOW DIRECTION	COMPATIBLE HOLDERS									RECOMMENDED FOR ISOLATION OF SAFETY RELIEF VALVE		AVAILABLE B.D.I. [®] OR BDI-FLX™ (1 INCH AND ABOVE)	AVAILABLE ASME  CERTIFICATION
		UNION	INSERT	FULL BOLTED	CLEAN-SWEEP	TITE-SEAL	SCREW TYPE	PRE-TORQUED	DOUBLE DISC	SANITARY	YES	NO		
 HPX[®]			+					+	+		+		+	+
 HPX-Ta™			+					+	+		+		+	+
 LOTRX[®]			+					+	+		+		+	+
 RCS			+					+	+		+		+	+
 SANITRX HPX[®]		No holder required. Installs between standard sanitary ferrules.								+	+		+	+
 SANITRX HPX[®] II		No holder required. Installs between standard sanitary ferrules.								+	+		+	+
 SANITRX[®] LPX		No holder required. Installs between standard sanitary ferrules.								+	+		+	+
 MICRO X[®]			+		+			+	+		+		+	+
 COMPOSITE FS			+		+	+	+	+	+		Non-Metallic Seal		+	+
 STANDARD 30° SEAT		+	+	+	+	+	+		+			+	+	+
 COMPOSITE 30° SEAT		+	+	+					+		Non-Metallic Seal		+	+
 CAL-VAC[®]			+							+		+	+	
 POS-A-SET[®]			+							+		+	+	
 ENVIRO-SEAL		No holder required. Installs between standard bore companion flanges.								Downstream Only			+	+
 GRAFSERT[®]		No holder required. Installs between standard bore companion flanges.									+		+	+

ULTRX[®], SANITRX[®], SANITRX[®] LP, MINTRX[®], STAR X[®], ZAP[®], VRD and KBA Rupture Discs available for maintenance replacement only.

REVERSE
ACTING

HPX® Rupture Disc



The **HPX® Rupture Disc** provides an industry leading selection of sizes, materials and burst ratings, as well as the versatility to optimize the operating ratio, manufacturing range and media type to the demands of your application. A high precision scored reverse acting rupture disc, the HPX® Rupture Disc is available with 90% or 95% operating ratios and is design tested for 250,000 cycles* from full vacuum to 95% of burst rating.

FEATURES/SPECIFICATIONS

- Sizes:**
1" - 12" (25mm - 300mm)
- Burst Pressure:**
10 - 2000 psig (0,689 - 138 barg)
- Manufacturing Range:**
ZERO, -5%, -10%
- Maximum Recommended Operating Ratio:**
Choice of 95% or 90%
- Available Maximum Temperature Limit:**
1000° F (538° C)
- Service:**
Gas or Liquid
- Nonfragmenting Design:**
Yes
- Withstand Full Vacuum:**
Yes
- Operating Conditions:**
Static, Cyclic or Pulsating
- Material(s):**
316 SS, 316L SS, HASTELLOY® C, Nickel, MONEL® and INCONEL®
- Seat Configuration:**
Flat seat
- Holders:**
HPX® Insert Holder
HPX®-RH (Reduced Height) Insert Holder
HPX-PT™ Pre-Torqued Insert Holder
HPX-PT™-RH Pre-Torqued Insert Holder
HPX® Double Disc Insert Holder
- Compatible with the Following Alarm System:**
BDI-FLX™ or B.D.I.®
- Tagging:**
Three dimensional stainless steel flow direction tag attached to all sizes
- For Additional Information Refer To:**
HPX® Rupture Disc Product Family Literature

HPX-Ta™ Rupture Disc



The **HPX-Ta™ Rupture Disc** is a Tantalum semicircular scored reverse acting rupture disc designed specifically for use in highly corrosive media, such as bromine, chlorine, HCL, nitric acid or sulphuric acid. In certain concentrations, temperatures and moisture conditions, Tantalum is frequently the only suitable rupture disc material for the application.

FEATURES/SPECIFICATIONS

- Sizes:**
1" - 12" (25mm - 300mm)
- Burst Pressure:**
10 - 800 psig (0,689 - 55,2 barg)
- Manufacturing Range:**
ZERO, -5%, -10%
- Maximum Recommended Operating Ratio:**
90%
- Available Maximum Temperature Limit:**
500° F (260° C)
- Service:**
Gas or Liquid
- Nonfragmenting Design:**
Yes
- Withstand Full Vacuum:**
Yes
- Operating Conditions:**
Static, Cyclic or Pulsating
- Material(s):**
Tantalum
- Seat Configuration:**
Flat seat
- Holders:**
HPX® Insert Holder
HPX®-RH (Reduced Height) Insert Holder
HPX-PT™ Pre-Torqued Insert Holder
HPX-PT™-RH Pre-Torqued Insert Holder
HPX® Double Disc Insert Holder
- Compatible with the Following Alarm System:**
BDI-FLX™ or B.D.I.®
- Tagging:**
Three dimensional stainless steel flow direction tag attached to all sizes
- For Additional Information Refer To:**
HPX® Rupture Disc Product Family Literature and/or HPX-Ta™ Rupture Disc Datasheet

* Tests performed on 316 SS and HASTELLOY® C



LOTRX® Rupture Disc



The **LOTRX® Rupture Disc** is a scored reverse acting rupture disc that utilizes failure initiating indents, a highly accurate manufacturing method to achieve and control a burst pressure at close tolerances, plus a precision semicircular score to provide a clean, consistent opening pattern. The LOTRX® Rupture Disc is designed for extremely low pressure applications below the range of the HPX® Rupture Disc product family.

FEATURES/SPECIFICATIONS

- Sizes:**
1" - 8" (25mm - 200mm)
- Burst Pressure:**
1.5 - 30 psig (0,103 - 2,07 barg)
- Manufacturing Range:**
ZERO, -5%, -10%
- Maximum Recommended Operating Ratio:**
90%
- Available Maximum Temperature Limit:**
1000° F (538° C)
- Service:**
Gas or Liquid
- Nonfragmenting Design:**
Yes
- Withstand Full Vacuum:**
Yes*
- Operating Conditions:**
Static, Cyclic or Pulsating
- Material(s):**
316 SS, 316L SS, HASTELLOY® C, Nickel, MONEL®, INCONEL® and Tantalum
- Seat Configuration:**
Flat seat
- Holders:**
LOTRX Insert Holder
- Compatible with the Following Alarm System:**
BDI-FLX™** or B.D.I.®
- Tagging:**
Three dimensional stainless steel flow direction tag attached to all sizes
- For Additional Information Refer To:**
Reverse Acting Rupture Discs and Holders Datasheet

* Limitations apply and product specific literature should be reviewed. See "For Additional Information" section above.
 ** BDI-FLX™ Burst Disc Sensor System should not be used for pressure ratings below the minimum rating listed in the BDI-FLX™ Burst Disc Sensor System Datasheet.

RCS Rupture Disc



The **RCS Rupture Disc** is a reverse acting, cross-scored, solid metal rupture disc, providing reliable pressure relief protection, easy installation, and retrofit to your pre-existing piping arrangement. Available in sizes outside the range of the HPX® Rupture Disc product family.

FEATURES/SPECIFICATIONS

- Sizes:**
14" - 32" (350mm - 800mm)
- Burst Pressure:**
20 - 180 psig (1,38 - 12,4 barg)
- Manufacturing Range:**
ZERO, -5%, -10%
- Maximum Recommended Operating Ratio:**
90%
- Available Maximum Temperature Limit:**
1000° F (538° C)
- Service:**
Gas Only
- Nonfragmenting Design:**
Yes
- Withstand Full Vacuum:**
Yes
- Operating Conditions:**
Static, Cyclic or Pulsating
- Material(s):**
316 SS, 316L SS, HASTELLOY® C, Nickel, MONEL® and INCONEL®
- Seat Configuration:**
Flat seat
- Holders:**
RCS Insert Holder, RCS Double Disc Insert Holder
- Compatible with the Following Alarm System:**
Universal B.D.I.®
- Tagging:**
Three dimensional stainless steel flow direction tag attached to all sizes
- For Additional Information Refer To:**
Reverse Acting Rupture Discs and Holders Datasheet

REVERSE
ACTING

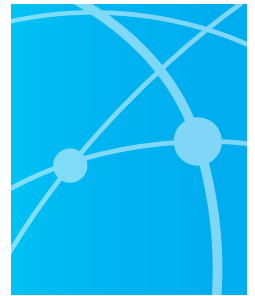

REVERSE
ACTING



SANITRX HPX® Rupture Disc



The **SANITRX HPX® Rupture Disc** is a semicircular scored reverse acting rupture disc designed for the pharmaceutical, biotech, food and beverage industries. This rupture disc is a high precision rupture disc available in your choice of 90 or 95% maximum recommended operating ratio and is a high performance rupture disc proven to withstand cycles from full vacuum to 95% of the stamped rating. SANITRX HPX® Rupture Discs comply with essential criteria of ASME BPE and USP Class VI.

FEATURES/SPECIFICATIONS

- Sizes:**
1" - 3" (25mm - 80mm)
- Burst Pressure:**
10 - 250 psig (0,689 - 17,2 barg)
- Manufacturing Range:**
ZERO, -5%, -10%
- Maximum Recommended Operating Ratio:**
Choice of 95% or 90%
- Available Maximum Temperature Limit:**
450° F (232° C)
- Service:**
Gas or Liquid
- Nonfragmenting Design:**
Yes
- Withstand Full Vacuum:**
Yes
- Operating Conditions:**
Static, Cyclic or Pulsating
- Material(s):**
316 SS, 316L SS, HASTELLOY® C, Nickel, MONEL® and INCONEL®
- Seat Configuration:**
IS, SF, NA
- Holders:**
Designed to install directly between standard sanitary ferrules
- Compatible with the Following Alarm System:**
BDI-FLX™ or B.D.I.®
- Tagging:**
Three dimensional stainless steel vertical flow direction tag attached to all sizes
- For Additional Information Refer To:**
HPX® Rupture Disc Product Family Brochure

SANITRX HPX® II Rupture Disc



The **SANITRX HPX® II Rupture Disc** is designed to expand the SANITRX HPX® product line into higher burst pressure ratings. The geometrically strengthened arcuate on the SANITRX HPX® II provides a radiused hinge point to prevent fragmentation of the rupture disc petal upon rupture. SANITRX HPX® II also adds the 4" size rupture disc to the SANITRX HPX® Rupture Disc product family.

FEATURES/SPECIFICATIONS

- Sizes:**
1 1/2" - 4" (40mm - 100mm)
- Burst Pressure:**
10 - 500 psig (0,689 - 34,5 barg)
- Manufacturing Range:**
ZERO, -5%, -10%
- Maximum Recommended Operating Ratio:**
Choice of 95% or 90%
- Available Maximum Temperature Limit:**
450° F (232° C)
- Service:**
Gas or Liquid
- Nonfragmenting Design:**
Yes
- Withstand Full Vacuum:**
Yes
- Operating Conditions:**
Static, Cyclic or Pulsating
- Material(s):**
316 SS, 316L SS, HASTELLOY® C, Nickel, MONEL® and INCONEL®
- Seat Configuration:**
IS, SF, NA
- Holders:**
Designed to install directly between standard sanitary ferrules
- Compatible with the Following Alarm System:**
BDI-FLX™ or B.D.I.®
- Tagging:**
Three dimensional stainless steel vertical flow direction tag attached to all sizes
- For Additional Information Refer To:**
HPX® Rupture Disc Product Family Brochure

SANITRX® LPX Rupture Disc



The **SANITRX® LPX Rupture Disc** is a stainless steel, reverse acting rupture disc designed specifically for the pharmaceutical, food & beverage, and biotech industries. The SANITRX® LPX Rupture Disc provides low pressure solutions for equipment operating in vacuum or very low pressure conditions.

FEATURES/SPECIFICATIONS

- Sizes:**
1-1/2" - 3" (40mm - 80mm)
- Burst Pressure:**
5.8 - 10 psig (0,40 - 0,689 barg)
- Manufacturing Range:**
ZERO
- Maximum Recommended Operating Ratio:**
90%
- Available Maximum Temperature Limit:**
450° F (232° C)
- Service:**
Gas Only
- Nonfragmenting Design:**
Yes
- Withstand Full Vacuum:**
Yes
- Operating Conditions:**
Static, Cyclic or Pulsating
- Material(s):**
316 SS, 316L SS
- Seat Configuration:**
IS, SF, NA
- Holders:**
Designed to install directly between standard sanitary ferrules
- Compatible with the Following Alarm System:**
BDI-FLX™* (2"-3" only) or B.D.I.®
- Tagging:**
Three dimensional stainless steel vertical flow direction tag attached to all sizes
- For Additional Information Refer To:**
SANITRX® LPX Rupture Disc Datasheet

* BDI-FLX™ Burst Disc Sensor System should not be used for pressure ratings below the minimum rating listed in the BDI-FLX™ Burst Disc Sensor System Datasheet.



REVERSE
ACTING



TENSION/
FORWARD
ACTING

MICRO X® Rupture Disc



The **MICRO X® Rupture Disc** is a cross-scored flat seat tension type rupture disc. It is designed for non-fragmentation with a four-petal opening.

FEATURES/SPECIFICATIONS

- Sizes:**
1" - 36" (25mm - 900mm)
- Burst Pressure:**
15 - 3600 psig (1,03 - 248 barg)
- Manufacturing Range:**
ZERO, -5%, -10%
- Maximum Recommended Operating Ratio:**
80%
- Available Maximum Temperature Limit:**
1000° F (538° C)
- Service:**
Gas or Liquid
- Nonfragmenting Design:**
Yes
- Withstand Full Vacuum:**
Yes*
- Operating Conditions:**
Static
- Material(s):**
316 SS, 316L SS, HASTELLOY® C, Nickel, MONEL®, INCONEL® and Tantalum
- Seat Configuration:**
Flat seat
- Holders:**
UNISERT® Insert Holder, CLEAN-SWEEP Holder
- Compatible with the Following Alarm System:**
BDI-FLX™ or B.D.I.®
- Tagging:**
Three dimensional stainless steel flow direction tag attached to all sizes
- For Additional Information Refer To:**
UNISERT® Assembly Datasheet

* Limitations apply and product specific literature should be reviewed. See "For Additional Information" section above.

Composite Flat Seat Rupture Disc



The **Composite Flat Seat Rupture Disc** is designed for systems requiring a lower burst pressure than offered in a MICRO X® Rupture Disc. Continental Disc Corporation's seven-hole center pattern provides a non-fragmenting design when used with a DUPONT™ TEFLON® fluoropolymer seal.

FEATURES/SPECIFICATIONS

- Sizes:**
1 1/16" - 36" (17,5mm - 900mm)
- Burst Pressure:**
2 - 1400 psig (0,138 - 99,3 barg)
- Manufacturing Range:**
Standard, 3/4, 1/2, 1/4, ZERO
- Maximum Recommended Operating Ratio:**
80%
- Available Maximum Temperature Limit:**
500° F (260° C)
- Service:**
Gas or Liquid
- Nonfragmenting Design:**
Yes (With DUPONT™ TEFLON® Fluoropolymer Seal)
- Withstand Full Vacuum:**
with Vacuum Support
- Operating Conditions:**
Static, Cyclic or Pulsating
- Material(s):**
316 SS, 316L SS, HASTELLOY® C, Nickel, MONEL®, INCONEL®, Tantalum, Aluminum, Silver and DUPONT™ TEFLON® Fluoropolymer
- Seat Configuration:**
Flat seat
- Holders:**
UNISERT® Insert Holder, Screw Type Holder, CLEAN-SWEEP® Holder
- Compatible with the Following Alarm System:**
BDI-FLX™ or B.D.I.®
- Tagging:**
Three dimensional stainless steel flow direction tag attached to 1" (25mm) and above
- For Additional Information Refer To:**
UNISERT® Assembly Datasheet
Tite-Seal and Screw Type Assembly Datasheet

Standard 30° Seat Rupture Disc



A **Standard Rupture Disc** is a solid metal, differential pressure relief device with an instantaneous, full-opening, non-reclosing design.

FEATURES/SPECIFICATIONS

Sizes:

1/4" - 30" (6mm - 750mm)

Burst Pressure:

3 - 75,000 psig (0,207 - 5171 barg)

Manufacturing Range:

Standard, 3/4, 1/2

Maximum Recommended Operating Ratio:

70%

Available Maximum Temperature Limit:

1000° F (538° C)

Service:

Gas or Liquid

Nonfragmenting Design:

No

Withstand Full Vacuum:

with Vacuum Support

Operating Conditions:

Static, Cyclic or Pulsating

Material(s):

316 SS, 316L SS, HASTELLOY® C, Nickel, MONEL®, INCONEL®, Tantalum, Aluminum and Silver

Seat Configuration:

30°

Holders:

Insert Holder, Full Bolted Holder, Union Holder, Screw Type Holder

Compatible with the Following Alarm System:

BDI-FLX™ or B.D.I.®

Tagging:

Three dimensional stainless steel flow direction tag attached to 1" (25mm) sizes and above except when used in a Union Holder

For Additional Information Refer To:

Standard Rupture Disc Datasheet
Tite-Seal and Screw Type Assembly Datasheet

Composite 30° Seat Rupture Disc



The **Composite Rupture Disc** is designed for systems requiring a lower burst pressure than offered in Standard discs. Continental Disc Corporation's seven-hole center pattern is designed for non-fragmentation when used with a DUPONT™ TEFLON® fluoropolymer seal.

FEATURES/SPECIFICATIONS

Sizes:

1" - 30" (25mm - 750mm)

Burst Pressure:

2 - 1440 psig (0,138 - 99,3 barg)

Manufacturing Range:

Standard, 3/4, 1/2, 1/4, ZERO

Maximum Recommended Operating Ratio:

80%

Available Maximum Temperature Limit:

500° F (260° C)

Service:

Gas or Liquid

Nonfragmenting Design:

Yes (With DUPONT™ TEFLON® Fluoropolymer Seal)

Withstand Full Vacuum:

with Vacuum Support

Operating Conditions:

Static, Cyclic or Pulsating

Material(s):

316 SS, 316L SS, HASTELLOY® C, Nickel, MONEL®, INCONEL®, Tantalum, Aluminum, Silver and DUPONT™ TEFLON® Fluoropolymer

Seat Configuration:

30°

Holders:

Insert Holder, Full Bolted Holder, Union Holder

Compatible with the Following Alarm System:

BDI-FLX™ or B.D.I.®

Tagging:

Three dimensional stainless steel flow direction tag attached except for use in a Union Holder

For Additional Information Refer To:

Composite Type Rupture Disc Datasheet

TENSION/
FORWARD
ACTING



ULTRA
LOW
PRESSURE

CAL-VAC® Rupture Disc



The **CAL-VAC® Rupture Disc** is a highly accurate pressure relief device for protecting vessels and equipment against damaging vacuum conditions. Proven features include:

- Designed to open on vacuum within a 6 INWC spread
- Pressure setting starting at 1 INWC
- Can be operated to within 1 INWC or 90%, dependent upon rating
- Dual directional pressure protection (positive or negative)
- Designed for non-fragmentation

FEATURES/SPECIFICATIONS

- Sizes:**
3" - 12" (80mm - 300mm)
- Burst Pressure:**
Positive: 2 - 150 psig (0,138 - 10,3 barg)
Vacuum: 1 - 115 INWC
- Manufacturing Range:**
Positive: Standard, 3/4, 1/2, 1/4, ZERO
Vacuum: 6 INWC spread
- Maximum Recommended Operating Ratio:**
Positive: 80%
Vacuum: 90% of MIN or within 1 INWC, whichever is greater
- Available Maximum Temperature Limit:**
400° F (204° C)
- Service:**
Gas or Liquid
- Nonfragmenting Design:**
Yes
- Withstand Full Vacuum:**
Not Applicable
- Operating Conditions:**
Static, Cyclic or Pulsating
- Material(s):**
316 SS, 316L SS, HASTELLOY® C, Nickel, MONEL®, INCONEL®, Tantalum and DUPONT™ TEFLON® Fluoropolymer
- Seat Configuration:**
Flat seat
- Holders:**
CAL-VAC® Sanitary Holder, CAL-VAC® Insert Holder
- Compatible with the Following Alarm System:**
Integral B.D.I.®
- Tagging:**
Insert Style: Three dimensional stainless steel flow direction tag attached
Sanitary Style: Unattached stainless steel tag provided
- For Additional Information Refer To:**
CAL-VAC® / POS-A-SET® Datasheet

POS-A-SET® Rupture Disc



The **POS-A-SET® Rupture Disc** is a highly accurate pressure relief device for protecting vessels and equipment against damaging positive pressure conditions. Proven features include:

- Designed to open on positive pressure within a 6 INWC spread
- Positive pressure setting starting at 1 INWC
- Can be operated to within 1 INWC or 90%, dependent upon rating
- Dual directional pressure protection (positive or negative)
- Designed for non-fragmentation

FEATURES/SPECIFICATIONS

- Sizes:**
3" - 12" (80mm - 300mm)
- Burst Pressure:**
Positive: 1 - 115 INWC
Vacuum: 2 - 150 psig (0,138 - 10,3 barg)
- Manufacturing Range:**
Positive: 6 INWC spread
Vacuum: Standard, 3/4, 1/2, 1/4, ZERO
- Maximum Recommended Operating Ratio:**
Positive: 90% of MIN or within 1 INWC, whichever is greater
Vacuum: 80%
- Available Maximum Temperature Limit:**
400° F (204° C)
- Service:**
Gas or Liquid
- Nonfragmenting Design:**
Yes
- Withstand Full Vacuum:**
Not Applicable
- Operating Conditions:**
Static, Cyclic or Pulsating
- Material(s):**
316 SS, 316L SS, HASTELLOY® C, Nickel, MONEL®, INCONEL®, Tantalum and DUPONT™ TEFLON® Fluoropolymer
- Seat Configuration:**
Flat seat
- Holders:**
POS-A-SET® Sanitary Holder, POS-A-SET® Insert Holder
- Compatible with the Following Alarm System:**
Integral B.D.I.®
- Tagging:**
Insert Style: Three dimensional stainless steel flow direction tag attached
Sanitary Style: Unattached stainless steel tag provided
- For Additional Information Refer To:**
CAL-VAC® / POS-A-SET® Datasheet

ENVIRO-SEAL Rupture Disc



The **ENVIRO-SEAL Rupture Disc** is a flat composite rupture disc, designed to provide economical isolation for low pressure atmospheric storage vessels or to isolate the downstream side of a pressure relief valve. ENVIRO-SEAL Rupture Discs are available in three designs:

- Type I: Burst in one direction only
- Type II & III: Burst in either direction, positive or vacuum, at the same burst pressure

FEATURES/SPECIFICATIONS

- Sizes:**
1" - 36" (25mm - 900mm)
- Burst Pressure:**
1 - 59 psig (0,069 - 4,07 barg)
- Manufacturing Range:**
See Composite Type Rupture Disc Datasheet for available MIN/MAX ratings
- Maximum Recommended Operating Ratio:**
50%
- Available Maximum Temperature Limit:**
400° F (204° C)
- Service:**
Gas or Liquid
- Nonfragmenting Design:**
Yes
- Withstand Full Vacuum:**
Not Applicable
- Operating Conditions:**
Static, Cyclic or Pulsating
- Material(s):**
316 SS, 316L SS, HASTELLOY® C, Nickel, MONEL®, INCONEL®, DUPONT™ TEFLON® Fluoropolymer
- Seat Configuration:**
Flat seat
- Holders:**
Designed to mount directly between standard bore ASME, DIN or JIS companion flanges
- Compatible with the Following Alarm System:**
Integral B.D.I.®
- Tagging:**
Three dimensional stainless steel flow direction tag attached to all sizes
- For Additional Information Refer To:**
Composite Type Rupture Disc Datasheet

GRAFSERT® Rupture Disc

Graphite Rupture Disc with armored ring

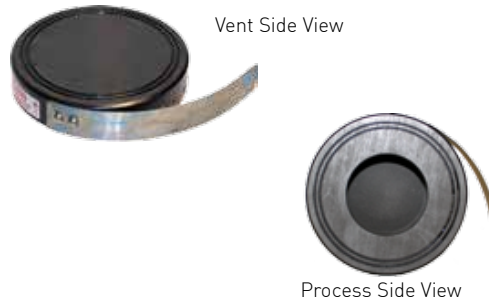

GRAFSERT® Rupture Discs are machined from a monolithic piece of graphite and impregnated with phenolic. Graphite discs are corrosive resistant to many chemicals.

FEATURES/SPECIFICATIONS

- Sizes:**
1/2" - 24" (13mm - 600mm)
- Burst Pressure:**
0.25 - 720 psig (0,017 - 49,6 barg)
- Manufacturing Range:**
ZERO
- Maximum Recommended Operating Ratio:**
80%
- Available Maximum Temperature Limit:**
700° F (371° C)
- Service:**
Gas or Liquid
- Nonfragmenting Design:**
No
- Withstand Full Vacuum:**
with Vacuum Support
- Operating Conditions:**
Static, Cyclic or Pulsating
- Material(s):**
Graphite
- Seat Configuration:**
Flat seat
- Holders:**
Designed to mount directly between standard bore ASME, DIN or JIS companion flanges
- Compatible with the Following Alarm System:**
Integral B.D.I.®
- Tagging:**
Stainless steel tag attached
- For Additional Information Contact Your:**
Sales Representative

TENSION/
FORWARD
ACTING



TENSION/
FORWARD
ACTING

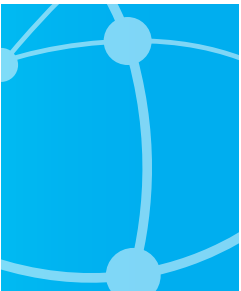

TITE-SEAL Rupture Disc Assembly



The **Tite-Seal Rupture Disc Assembly** is an economical "throwaway" sealed unit available with 1/4", 3/8", 1/2", 3/4" or 1" MNPT inlet connections and outlet configurations with an MNPT connection, muffled or free vent.

FEATURES/SPECIFICATIONS

- Sizes:**
1/4" - 1" (6mm - 25mm)
- Burst Pressure:**
13 - 3000 psig (0,90 - 207 barg)
- Manufacturing Range:**
-10% or Standard*
- Maximum Recommended Operating Ratio:**
Choice of 90%, 80% or 70%*
- Available Maximum Temperature Limit:**
400° F (204° C)
- Service:**
Gas or Liquid
- Nonfragmenting Design:**
With SRA or CDCV rupture disc
- Withstand Full Vacuum:**
Yes
- Operating Conditions:**
Static, Cyclic or Pulsating
- Material(s):**
316 SS, 316L SS, HASTELLOY® C, Nickel, MONEL®, INCONEL®, Aluminum, Silver, DUPONT™ TEFLON® Fluoropolymer and Brass
- Seat Configuration:**
Flat seat
- Holders:**
Designed to mate with threaded connections
- Compatible with the Following Alarm System:**
Not available
- Tagging:**
Marked on assembly
- For Additional Information Refer To:**
Tite-Seal and Screw Type Assemblies Datasheet

** Dependent upon the type of rupture disc selected, limitations apply and product specific literature should be reviewed. See "For Additional Information" section above.*

WMP™ Rupture Disc Assembly



The **WMP™ (Welded Muffled Plug) Rupture Disc Assembly** is a single use unit that is threaded into a pressure system. The rupture disc assembly is designed to relieve the pressure of the process media in an over pressure condition to protect equipment, personnel and the environment from catastrophic failure of the pressure equipment or system. It is designed for applications with discharge to atmosphere at the rupture disc location.

FEATURES/SPECIFICATIONS

- Sizes:**
1/8" - 1" (3mm - 25mm)
- Burst Pressure:**
300 - 15000 psig (20,7 - 1034 barg)
- Manufacturing Range:**
-10%
- Maximum Recommended Operating Ratio:**
70%
- Available Maximum Temperature Limit:**
900° F (482° C)
- Service:**
Gas or Liquid
- Nonfragmenting Design:**
No
- Withstand Full Vacuum:**
Yes
- Operating Conditions:**
Static, Cyclic or Pulsating
- Material(s):**
316 SS, 316L SS, HASTELLOY® C, Nickel and INCONEL®
- Seat Configuration:**
Flat seat
- Holders:**
Designed to mate with threaded connections
- Compatible with the Following Alarm System:**
Not available
- Tagging:**
Marked on assembly
- For Additional Information Refer To:**
WMP Welded Muffled Plug Datasheet

ICON/ICON-TL Rupture Disc



The **ICON/ ICON-TL Rupture Disc** is a cross-scored, non-fragmenting design solid metal rupture disc specifically designed to protect transportation vessels like intermodal tank containers (common in Europe and Asia), railroad tank cars, tank trucks, and other vessels that transport liquids or gas products.

FEATURES/SPECIFICATIONS

- Sizes:**
65mm and 80mm
- Burst Pressure:**
3,67 barg
4,10 barg
4,84 barg
- Manufacturing Range:**
ZERO
- Maximum Recommended Operating Ratio:**
85% of the minimum performance tolerance
- Available Maximum Temperature Limit:**
400° F (204° C)
- Service:**
Gas or Liquid
- Nonfragmenting Design:**
Yes
- Withstand Full Vacuum:**
Yes
- Operating Conditions:**
Static, Cyclic or Pulsating
- Material(s):**
Nickel, 316 SS, DUPONT™ TEFLON® Fluoropolymer
- Seat Configuration:**
Flat seat
- Holders:**
Designed to mount directly to tank flanges
- Compatible with the Following Alarm System:**
Not available
- Tagging:**
Stainless steel tag attached
- For Additional Information Refer To:**
Transportation Protection Datasheet

PC-SERT Rupture Disc



The **PC-SERT Rupture Disc** is a composite type rupture disc designed to protect transportation vessels such as intermodal tank containers, railroad portable containers, tank cars, over-the-road tank trucks and other vessels that transport liquids or gas products, from potentially damaging overpressure conditions.

FEATURES/SPECIFICATIONS

- Sizes:**
65mm and 80mm
- Burst Pressure:**
20 - 200 psig (1,38 - 13,8 barg)
- Manufacturing Range:**
ZERO
- Maximum Recommended Operating Ratio:**
85% of the minimum performance tolerance
- Available Maximum Temperature Limit:**
400° F (204° C)
- Service:**
Gas or Liquid
- Nonfragmenting Design:**
Yes
- Withstand Full Vacuum:**
With Vacuum Support
- Operating Conditions:**
Static, Cyclic or Pulsating
- Material(s):**
316 SS, 316L SS, MONEL®, INCONEL®, HASTELLOY® C, Nickel, DUPONT™ TEFLON® Fluoropolymer
- Seat Configuration:**
Flat seat
- Holders:**
Designed to mount directly to tank flanges
- Compatible with the Following Alarm System:**
Not available
- Tagging:**
Stainless steel tag attached
- For Additional Information Refer To:**
Transportation Protection Datasheet

TANKSERT Rupture Disc



The **Tanksert Rupture Disc** is designed for use on railroad tank cars, over the road tank trucks and other transportable vessels. It is designed to fit both threaded and bolted type Safety Vent Assemblies. Available with optional bee screen.

FEATURES/SPECIFICATIONS

- Sizes:**
2" (50mm)
- Burst Pressure:**
25 - 165 psig
- Manufacturing Range:**
Standard Pressure Ranges
- Maximum Recommended Operating Ratio:**
80% of the minimum burst pressure
- Available Maximum Temperature Limit:**
400° F (204° C)
- Service:**
Gas or Liquid
- Nonfragmenting Design:**
Yes
- Withstand Full Vacuum:**
Yes
- Operating Conditions:**
Static, Cyclic or Pulsating
- Material(s):**
316 SS, DUPONT™ TEFLON® Fluoropolymer
- Seat Configuration:**
Flat seat
- Holders:**
Designed to fit both threaded and bolted type customer supplied safety vent assemblies
- Compatible with the Following Alarm System:**
Not available
- Tagging:**
Marked on rupture disc
- For Additional Information Refer To:**
Transportation Protection Datasheet

TENSION/
FORWARD
ACTING

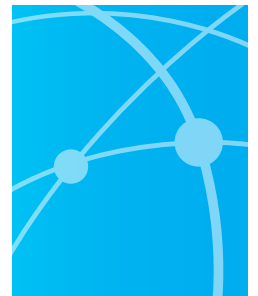

**VENT
PANELS**

VENT PANELS



Continental Disc Corporation **Vent Panels** are designed to allow full, instantaneous opening, thus minimizing structural or mechanical damage that may be caused by the deflagration of dust, gas or mist.

Our Vent Panels feature:

- Full, instantaneous opening under dynamic or static pressure conditions
- Designed for non-fragmentation
- Available in square, rectangular or circular configurations
- Interchangeable with many existing applications
- B.D.I.® Alarm System compatible

Vent Panel Types

Continental Disc Corporation vent panels are offered in the following types of construction:

VP Series:

The VP series vent panel is a flat, scored aluminum panel, DUPONT™ TEFLON® fluoropolymer coated, for applications requiring protection to as low as 1 psig. This panel may be used for positive pressure or vacuum pulsating conditions.

CP Series:

The CP series flat composite vent panel is excellent for applications requiring cyclic conditions (positive to negative pressures), low opening pressures and the need for stainless steel construction.

SFC and CFC Series:

The SFC and CFC series prebulged vent panels are excellent for applications operating up to full vacuum. The SFC series are prebulged, circular, solid aluminum vent panels with a handling or vacuum support. The CFC series are prebulged, circular composite vent panels with a handling or vacuum support, usually made of 316SS and DUPONT™ TEFLON® fluoropolymer components.

CFR and CFS Series Formed Vent Panels:

The CFR (rectangular) and CFS (square) series are prebulged 316SS vent panels with vacuum support and DUPONT™ TEFLON® fluoropolymer seal. The CFR and CFS vent panels have an operating ratio of up to 80% of the minimum tagged rating.

**FEATURES/
SPECIFICATIONS**

Sizes:

- Rectangular or Square:
12" x 12" - 44" x 69"
(30 cm x 30 cm - 112 cm x 175 cm)
- Circular:
10" - 44" diameter
(25 cm - 112 cm)

Operating conditions:

- Flat panels: Up to 50% of rated burst pressure for positive or vacuum conditions
- Preformed (prebulged): Up to 80% of rated burst pressure for positive pressure and up to full vacuum

Temperature:

To 450° F (232° C)

Burst pressure:

1 to 10 psig @ 72° F
(0,069 to 0,689 barg @ 22° C)

Service:

Gaseous, static, pulsating or cyclic

Holder:

Lightweight flange construction

Alarm system:

B.D.I.® Alarm System compatible

Options:

Coatings, vacuum support, dent protector

For Additional Information Refer To:

- VENT PANELS Datasheet
- CFR & CFS FORMED VENT PANELS Datasheet



BURST DISC INDICATOR Alarm Systems



BDI-FLX™ BURST DISC SENSOR SYSTEM



B.D.I.® ALARM SYSTEM

Continental Disc Corporation provides two systems for monitoring the burst of a rupture disc, the BDI-FLX™ Sensor System and the B.D.I.® Alarm System. Common features include:

- Detects venting, provides instantaneous notification of the bursting of a rupture disc.
- Signals emergency equipment, control room and/or operating personnel to alter or stop a process.
- Can be combined with a CDC Alarm Monitor to protect equipment, lives and the environment.

The **BDI-FLX™ Burst Disc Sensor System** provides many benefits, which include:

- Allows direct interface to PLC's, DCS (Distributed Control System), alarm monitors or isolating barriers and can provide dry contacts for industrial controls.
- Improved durability:
 - The conductive element is fully encapsulated in corrosive resistant polyimide film
 - The advanced technologies of the sensor strip minimize the risk of damage due to excessive stress beyond recommended bolting load
 - The alignment ring provides a rigid support for the new sensor cable, minimizing cable strain
- Modernized output cable connectors in accordance with IEC 61076-2-101. IP67 rated M12 connector.

For Additional Information Refer To: BDI-FLX™ Burst Disc Sensor System Datasheet

The **B.D.I. Burst Disc Indicator Alarm System** provides many benefits, which include:

- Expanded availability in sizes up to 36" (900mm)
- Available as integral design to many rupture disc and vent panel products

For Additional Information Refer To: B.D.I.® Burst Disc Indicator Datasheet

MTB-700 ALARM MONITOR



The MTB-700 Alarm Monitor incorporates intrinsically safe galvanically isolated barriers, approved for use in many countries worldwide. An MTL5018AC barrier is utilized on the MTB-700 Alarm Monitor with a 120/240 VAC input power option. An MTL5018 barrier is utilized on the MTB-700 Alarm Monitor with the 24 VDC input power option. Upon disc rupture, these barriers activate signals and/or output relays to warn operators and actuate pumps, valves or other equipment connected to the system.

ALARM SYSTEMS

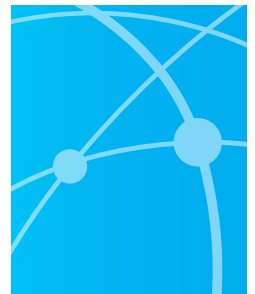

**SPECIAL
ASSEMBLIES****SPECIAL ASSEMBLIES****Solutions...for Tough Pressure Relief Problems**

Whether it's from the standard product line, or a custom-manufactured rupture disc for a one-of-a-kind application, Continental Disc Corporation has built a reputation for solving the toughest pressure relief problems for OEM's...Defense...Space Exploration...Aircraft and Aerospace...Chemical and Petrochemical... Food Processing...Electronics...and countless more.

Problem Solving

Continental Disc Corporation's custom manufacturing capabilities have been tapped for such wide-ranging projects as air conditioning units, oxygen supply systems, aircraft ejection seats, sonobouys and the space shuttle.

The same engineering, testing and manufacturing talent that has solved one-of-a-kind problems for worldwide industries is now available to deliver innovative solutions for your specific pressure relief problems.

Working With Specialized Technologies...Like Yours

Solving pressure relief problems for you is the special role played by Continental Disc Corporation's Product Development Group and the Special Products Group. This pool of product development expertise has been retrofitting Continental Disc Corporation products into clients' systems for nearly 50 years. They are engineers who are at home with special or exotic materials, ultrahigh or ultralow burst pressures, as well as state-of-the-art processing and testing requirements.

Whether your needs are for quantities of one or one hundred thousand, Continental Disc is ready to solve your pressure relief problems.

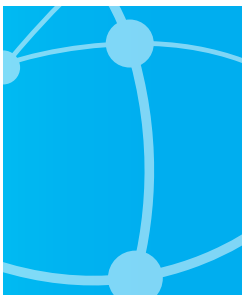

RUPTURE DISC HOLDERS

HOLDER OPTIONS

Continental Disc Corporation holders are available in a variety of types and styles to meet your needs. The rupture disc selection table on pages 6-7 shows which holder types are compatible with each type of rupture disc..

Continental Disc Corporation offers an extensive line of holders including:

- Insert Holders
- HPX-PT™ Pre-Torqued Holders
- Double Disc Holders
- Full Bolted Holders
- Screw Type Holders
- Union Type Holders
- CAL-VAC®/POS-A-SET® Sanitary Holders
- Union Type Holders
- CLEAN-SWEEP® Holders

Consult your Continental Disc Corporation representative or the factory for those applications needing additional features or modification.

SEALING CAPABILITIES

Continental's holder designs provide superior sealing capabilities to prevent product loss or contamination. The tapered seat configuration of Continental's HPX®, UNISERT®, and RCS holders outperforms other, similar designs, without the need for "pre-torque" arrangements. However, a pretorque-able holder is available for those customers who desire one, or whose specifications require it.

HPX-PT™ Pre-Torqued & HPX-PT™-RH Holders

HPX-PT™ Pre-Torqued and HPX-PT™-RH Holders incorporate high strength steel socket head cap screws to ensure accurate loading and sealing of the HPX® Rupture Disc. The HPX-PT™ Holder allows the disc to be correctly fitted in the workshop using precise recommended torque levels, prior to installation of the complete assembly between the flanges in the process system relief stream.

INSERT HOLDERS

Insert type rupture disc holders fit between two ASME, DIN or JIS companion flanges, as shown in the photograph to the right. Insert holders to fit other standards are available. These holders are designed for many different rupture disc styles, described in paragraphs 1 through 4 below. Common features of Continental Disc Corporation's Insert Holders include:

- Fit within companion flange bolts, allowing easy installation and removal
- Pre-assembly clips are standard and provide means to assemble the rupture disc and holder together before installation in piping system
- Stainless steel flow direction nameplates permanently attached to the holder
- Stainless steel customer identification tag permanently attached

1. 7I Insert holders, designed for Standard and Composite rupture discs, are available in 30° light or heavy lip configurations, dependent upon size and bolting class.
2. The UNISERT® Insert Holder has a flat seat configuration for use with either a MICRO X® or Composite Flat Seat Rupture Disc. Holder alignment pins and matching notches in the rupture disc provide correct rupture disc orientation in the holder. A J-Hook, along with flow direction arrows on the nameplate, aids in proper assembly installation between the companion flanges.
3. The HPX®, HPX®-RH and LOTRX® Insert Holders are designed with either a tapered or flat raised seat on the holder inlet. This design allows a uniform seal load on the mating rupture disc. Each holder has three round pins and the mating rupture disc is identically notched, providing proper rupture disc orientation in the holder. A J-Hook and flow direction arrows on the nameplates aid in the correct assembly orientation between companion flanges.
4. The RCS Insert Holder is designed for simplicity and safety of installation with superior sealing capabilities. A tapered seat configuration allows a uniform seal load on the rupture disc.
5. The CAL-VAC®/POS-A-SET® Insert Holders are designed with flat raised seat that allows for a uniform seal load on the mating rupture disc. Holder alignment pins and mating notches in the rupture disc provide correct rupture disc orientation in the holder. A Knifeblade Assembly with PRECISION-HONED EDGES is permanently affixed in the holder to provide maximum ultra low pressure relief. A J-Hook, along with flow direction arrows on the nameplate, aids in proper assembly installation between the companion flanges.



RUPTURE DISC HOLDERS

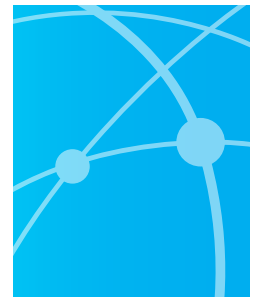

**RUPTURE
DISC
HOLDERS**

RUPTURE DISC HOLDERS

DOUBLE DISC HOLDERS



A Double Disc Holder Assembly consists of three holder components: an inlet, a mid-flange and an outlet piece, along with two rupture discs. The first of the two rupture discs is located between the inlet and the mid-flange, and the second rupture disc is between the mid-flange and outlet.

This assembly arrangement provides the solution to multiple applications without the need of a more complicated piping arrangement.

Double disc holders are available for:

- > HPX®
- > UNISERT
- > LOTRX®
- > 7I
- > RCS

CLEAN-SWEEP® Rupture Disc Holder



The CLEAN-SWEEP® Holder is designed for systems handling viscous media processes, particularly where product build-up in a piping system may cause excessive overpressure conditions.

This holder is an ideal replacement for rupture discs installed off the leg of a pipe tee where product build-up could affect the proper operation of the rupture disc.

The CLEAN-SWEEP® Holder body is specifically designed for a rupture disc.

The rupture disc is mounted directly on the holder body adjacent to the process flow. Compared to other designs, the CLEAN-SWEEP® greatly reduces the possibility of product build-up under the rupture disc and it is available for pressures up to 1440 psig [99,3 barg].

UNION TYPE HOLDERS



Union Type Holders are available for pressure ranges up to 6,000 psig, depending on disc size. All sizes are available with threaded or welded inlets in combination with threaded, welded or muffled outlets. Special unions are available.

FULL BOLTED HOLDERS



Full Bolted Holders do not need companion flanges. The proper seat configuration is machined directly into the flange. Full bolted holders are available in 30° light or heavy lip seat configurations, dependent upon size.

Welded, threaded or flat faced inlets and outlets are available. Stainless steel flow directional nameplates are provided.

SCREW TYPE HOLDERS



Screw Type Holders are available for pressures ranging up to 15,000 psig. The Screw Type holder is supplied with 1/4" or 1/2" MNPT inlet threads in combination with MNPT, free or muffled outlets. The 1/2" Standard and 11/16" Composite Rupture Disc are used in these holders. Special high pressure designs are available.

CAL-VAC®/POS-A-SET® Sanitary Fitting Holders



The CAL-VAC® and POS-A-SET® Sanitary Fitting Holder utilizes quick disconnect clamping that provides a secure, leak-tight joint, free of pockets or crevices and permits fast installation. A knifeblade assembly with precision honed edges is located in the holder and is designed to provide ultra low pressure relief.

The CAL-VAC® and POS-A-SET® Sanitary Fitting Holder is ideally suited for a wide range of applications where contamination and corrosion are hazards. It is designed to comply with 3A Sanitary Standards.

MARKETS & APPLICATIONS SERVED by Continental Disc Corporation Products

From very tiny to very large, from extreme compression to barely a breath, Continental Disc Corporation has been manufacturing rupture discs (bursting discs) to operate in every application you can imagine. The list below shows just a few of the places where Continental rupture discs are doing the job. If you don't see your application listed, just contact us and let us show you how we have handled pressure problems just like yours.

CHEMICAL INDUSTRY

- Pressure Vessels for Primary Pressure Relief
 - Reactors, Spheres, Towers, Cylinders
 - Safety Relief Valve Isolation
- Shell and Tube Heat Exchangers
 - Low Pressure Side
 - High Pressure Side
- Pump Discharge to Prevent Blocked Discharge
- Utilities
 - Heating or Cooling Systems (Dowtherm®, Ammonia, Freon)
 - Steam
 - Cryogenic Gasses
 - Headers, Knock Out Drums, Flares, Thermal Oxidizers

OIL & GAS INDUSTRY

- Land-Based & Offshore Well-Drilling & Servicing
- Offshore Platforms & Pumping Stations
 - Double Discs for FPSO Heat Exchangers
- Refinery Operations
- Pipeline Pumping Stations

PHARMACEUTICAL & COSMETICS INDUSTRY

- Specialty Chemical (API) Manufacturing
- Hygienic Service for Human & Animal Health Products
 - Chemical Processing Vessels
 - Specialty Chemical Processing Equipment— Filters, Chromatographs, Autoclaves, Fermentation
 - Clean Steam for Cleaning or Process System
 - Storage Tanks for Chemicals & Finished Product
 - Clean-In-Place & Sterilize-In-Place Systems
 - Skid & Module Manufacturers

PULP & PAPER INDUSTRY

- Digester Pressure Protection
- Bleaching System
- Refiner Housing Pressure Protection
- Non-Condensable Gas Recovery & Discharge Header
- Chemical Processing Vessels

FOOD & BEVERAGE INDUSTRY

- Process Vessels for Aseptic Service
- Storage Vessels for Aseptic Service
- Stainless Steel Storage Vessels
- Clean Steam Systems for Processing & Cleaning Systems
- Fermentation Vessels
- Pump Discharge Lines
- Special Process Equipment

SPECIALTY GAS INDUSTRY

- Separation Towers (Oxygen, Nitrogen, Hydrogen, CO₂, Argon)
- Shell & Tube Heat Exchangers
- High & Low Pressure Storage Vessels
- Field Service Applications
- Transportation Tanks
- OEM's for Cylinders, Vessels, Trailers

ADDITIONAL SPECIALTY MARKETS

- Plastic Extrusion
- Chiller Systems (Ammonia or Freon)
- Mining
- Oilfield Service Industry
- Electrical Switchgear or Transformers
- Aircraft, Aerospace & Military Equipment
- Ultra-Pure Semiconductor Gas Systems
- High Pressure Hydraulics
- High Pressure Tanks
 - Municipal & Industrial Plants
 - Transition from Thermal to RO Technology
- Geothermal Energy
- LNG (Import and Export)
- Solar Energy
- Wind Energy
- Syngas
 - Biodiesel
 - Ethanol
 - Algae
 - Coal to Gas

MARKETS SERVED

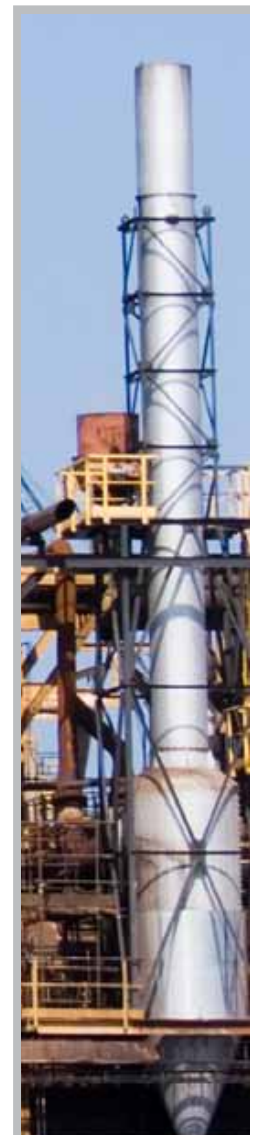
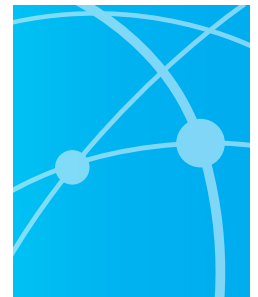

Other Mento products

OILFIELD SUPPLY

- Riser Tensioner Fluids
- BOP Control Fluids



- Environmentally friendly
- Thread Compounds
 - Jacking system grease
 - Valve grease



Diaphragm Pumps N° 403-M



MECHANICAL SOLUTIONS

- Engineering
- Machining
- Fabrication
- Service

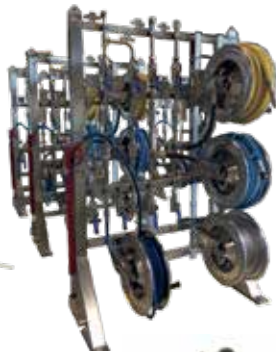

FILTRATION



All brands Filter Units for • Engine • HVAC • Process & Diesel

Membrane Filter



Tailor made Filter Solutions



FLOWLINE EQUIPMENT

Sale • Rental • Service



HOSES

Five Hoses • Two Fittings • One Solution

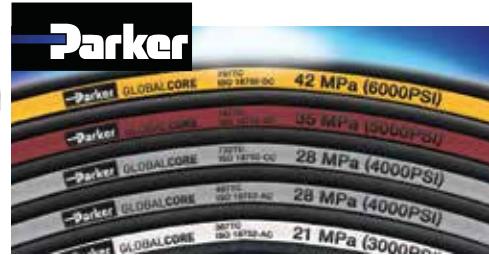

Flexible Choke & Kill Line with TauroFlon™ liner (up to 130°C)

Hoses for all types of media



Wide range of Bulk Loading Hoses

VALVES

Mud, API Gate & Chokes



Plug Valves

Gate, Globe & Check

Butterfly Valves (soft seat & high performance)

Ball

Control Valves



Contact Mento for more information

MENTO

Your link to improved performance

STAVANGER • BERGEN • KRISTIANSUND • HAMMERFEST
+47 48 11 03 00 • 24h +47 90 19 51 55 • post@mento.no • mento.no